

Model: YCDH-288-1

Technical Specification



General Information

Yixing YCDH-288-1 dome joint closure possesses large capacity and different types. It also meets the needs of bundle and ribbon for our consumers to elect.

Feature

7 ports. 1 elliptical port for ϕ 8-20mm uncut cable. Other 6 ports are branch ports, which is suitable for cables with diameter of 8-18mm.

Bundle range from 24 cores to 288 cores, with a maximum of 288 cores. The closure is available for 6 cores ribbon cable as well, up to 720 cores.

Good sealing performance. For wall mount, pole mount, manhole installation are easy to operate.

Welded pipe cassette deck could be replaced to meet the requirement of ribbon and bundle welded pipe placement. At the same time, micro type splitters can be installed.

Specification

External dimension (\pm5)	480 X 260 mm	Material	ABS+PC
Max Capacity	288	Color	black
Splicing tray	24F/tray	IP grade	IP68
Inlet cable port	ϕ 8-20 mm	Inlet/outlet	1 / 6
Outlet cable port	ϕ 8-20 mm	Cable port Sealing Type	Heat shrink seal





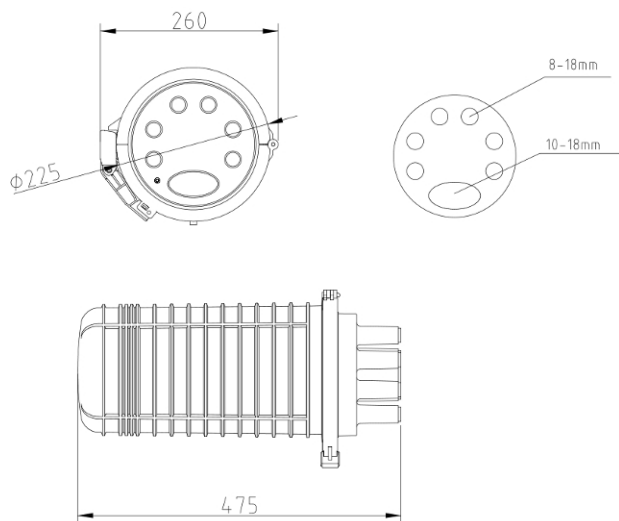



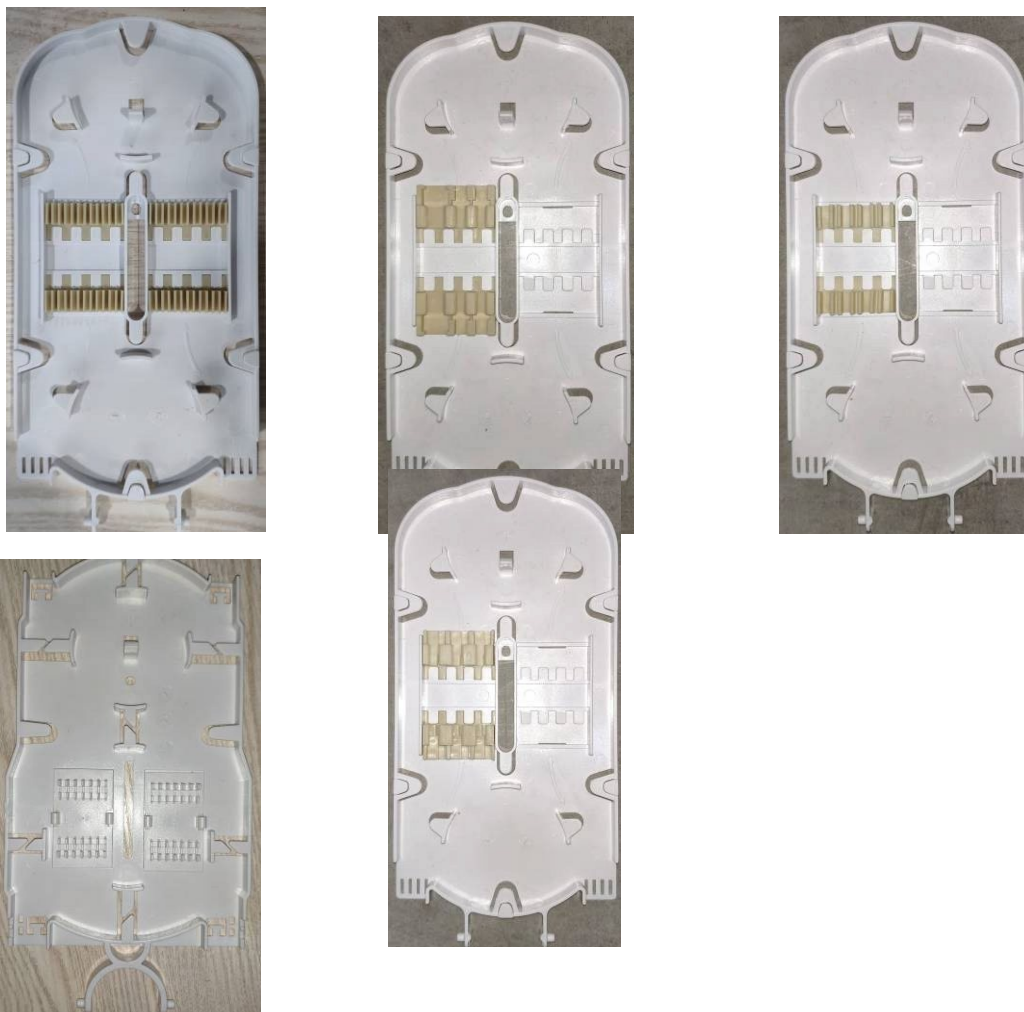

Structure Drawing



Ordering information







Accessories:
Standard accessories

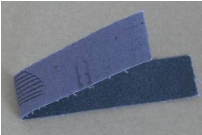



No.	Name	Number	Pic
1	Large heat shrinkable tube	1	
2	Medium-sized heat-shrinkable tube	4	
3	Small heat shrinkable tube	12	
4	Branching clamp	1	
5	Aluminum foil tape	17	
6	Insulating tape	1	
7	Fused pipe	On demand	
8	Tie band	On demand	
9	Clean paper	1	

Yixing Closure Dome Type Heat Shrink

10	Sandpaper	1	
11	Instructions	1	
12	Bare fibre protective tube	On demand	

Optional accessory:

No.	Name	Number	Pic
1	Gas nozzle	1	
2	Earthing	1	
3	Column Hanging Hoop Assembly	1	
4	Wall mounting assembly	1	

5	Overhead mounting assembly	1	
6	Stainless steel overhead assembly	1	
7	Stainless steel wall mounting assembly	1	
8	Stainless steel wall mounting assembly	1	
9	Stainless steel column mounting assembly	1	